



---

# Conceptual Dependency

- ATRANS – abstract transfer (give)
- PTRANS – physical transfer (move)
- PROPEL – application of force (push)
- MTRANS – mental transfer (tell)
- MBUILD – construct new information
- SPEAK – utter a sound (say)
- ATTEND – focus on a stimulus (watch)
- MOVE – move a body part (kick)
- GRASP – grasp an object (clutch)
- INGEST – ingest something (eat, inject)
- EXPEL – expel something (spit)



---

# Primitive Things

- PP – Real world objects (people, things)
- ACT – Real world actions (eat, give)
- PA – Attributes of objects (size, health)
- AA – Attributes of actions
- T – Times
- LOC – Locations



---

# Connections

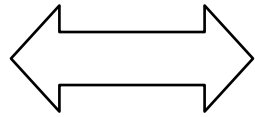

- link actors to actions



- dependencies



- conditionals

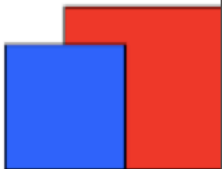



Mary gives John the book.



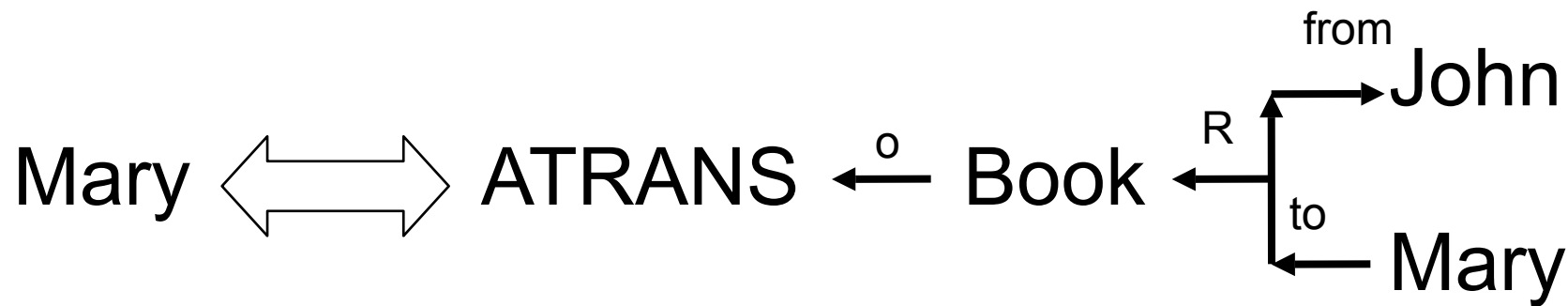

Book is the object

Mary

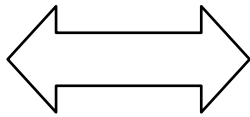

ATRANS



Book

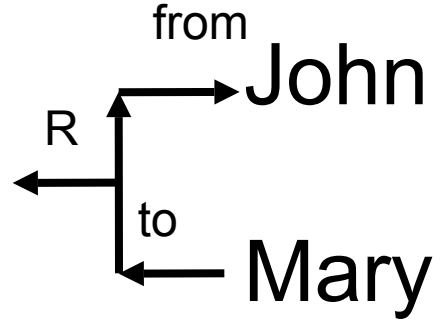

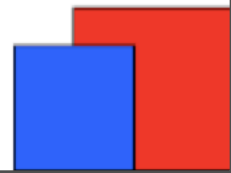
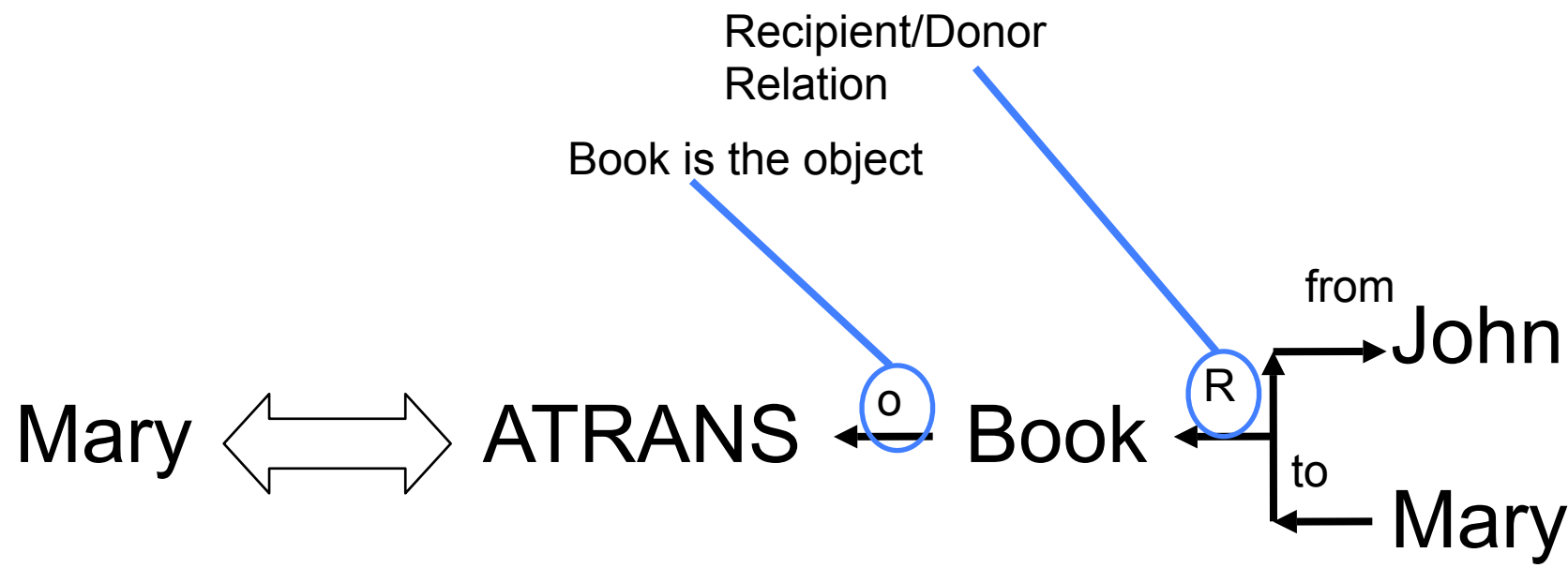

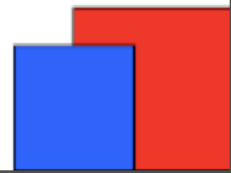
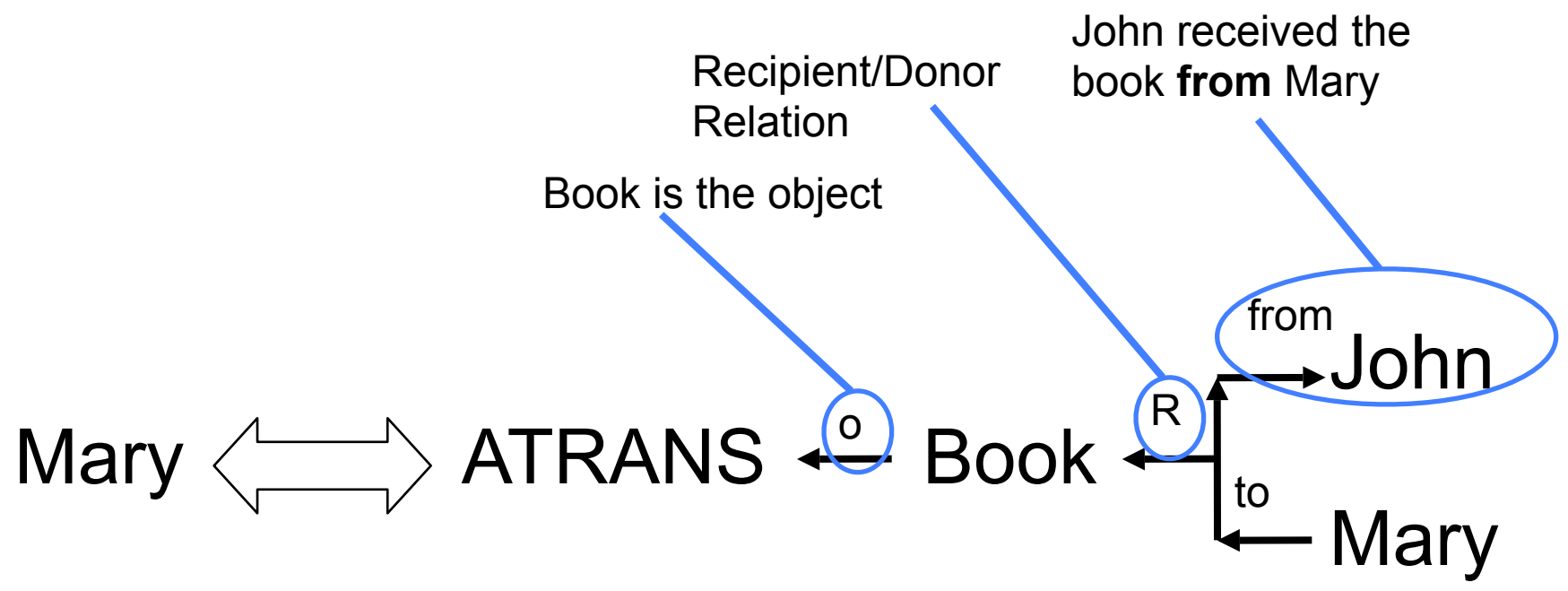



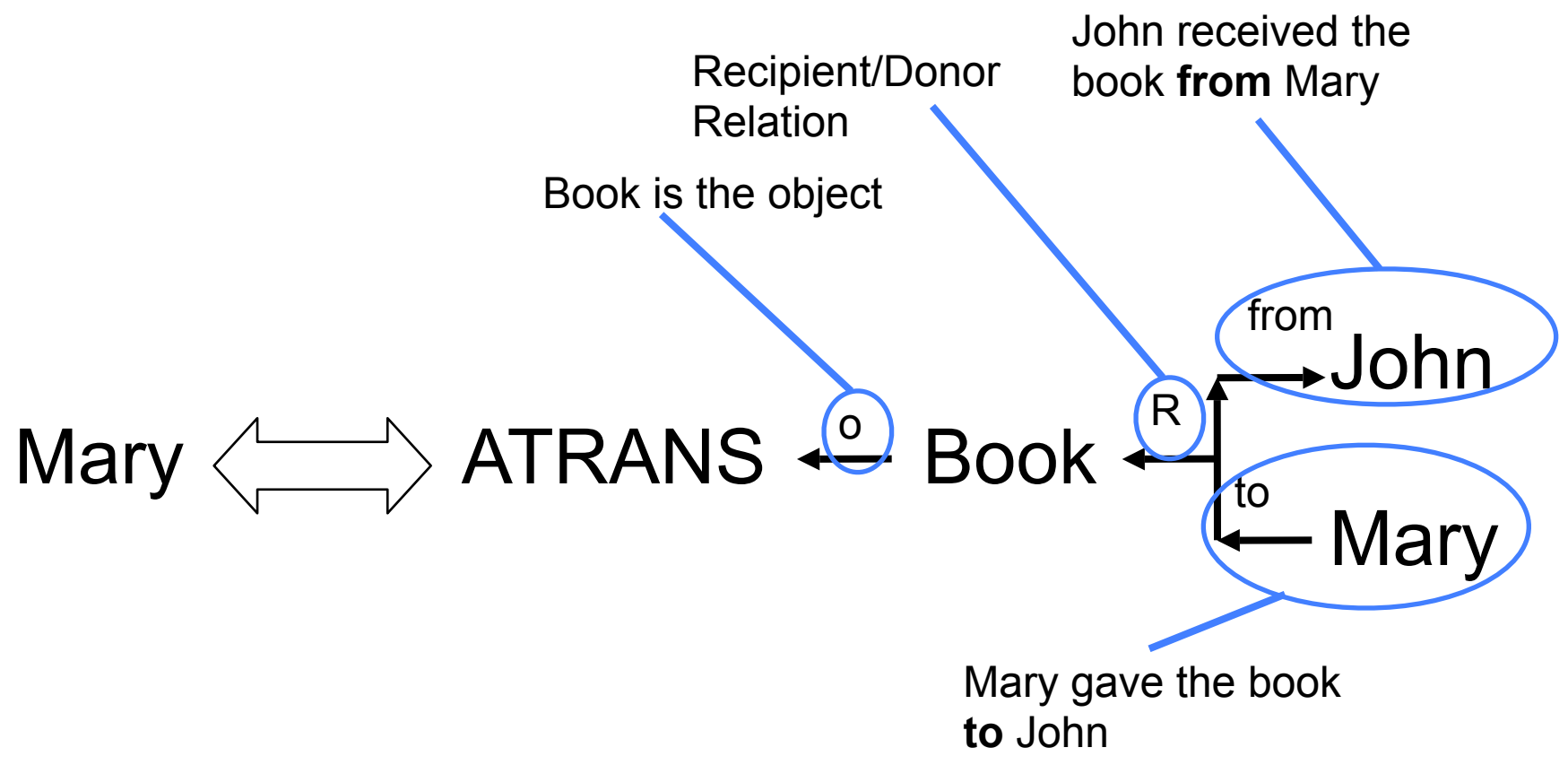



Mary gave John the book.



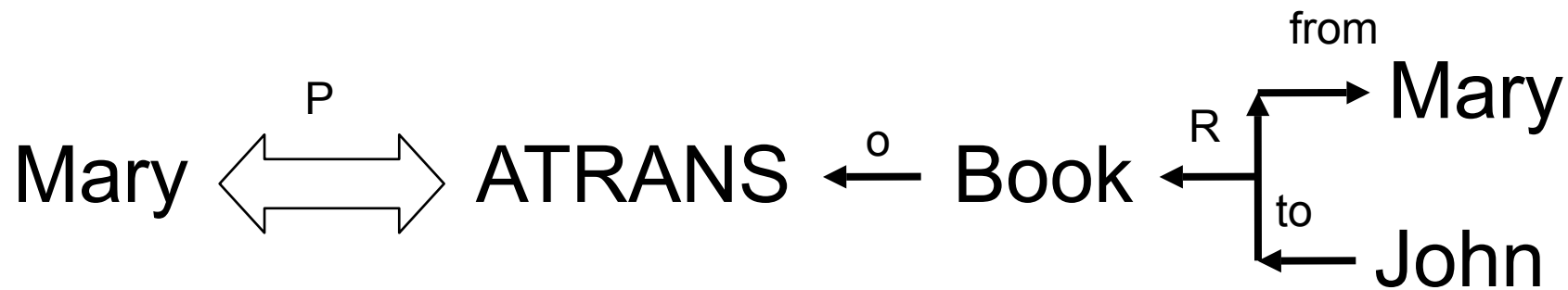



Past tense (P)

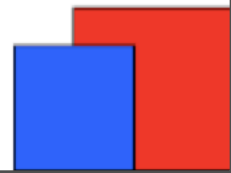
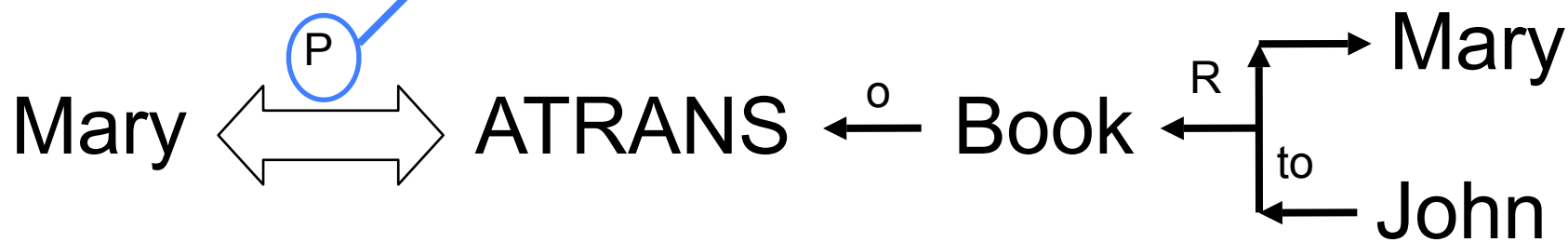



Mary will give John the book.



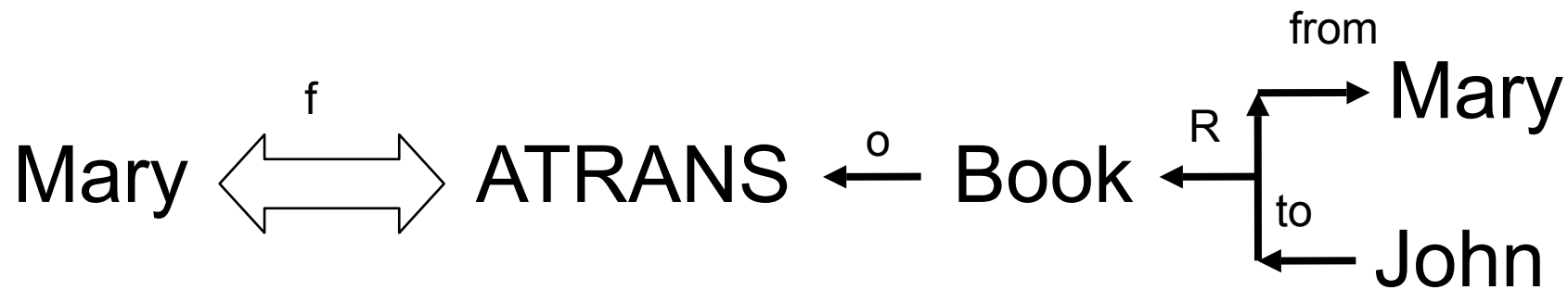



Future tense (f)

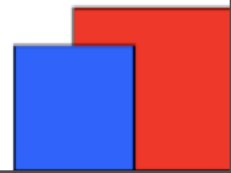
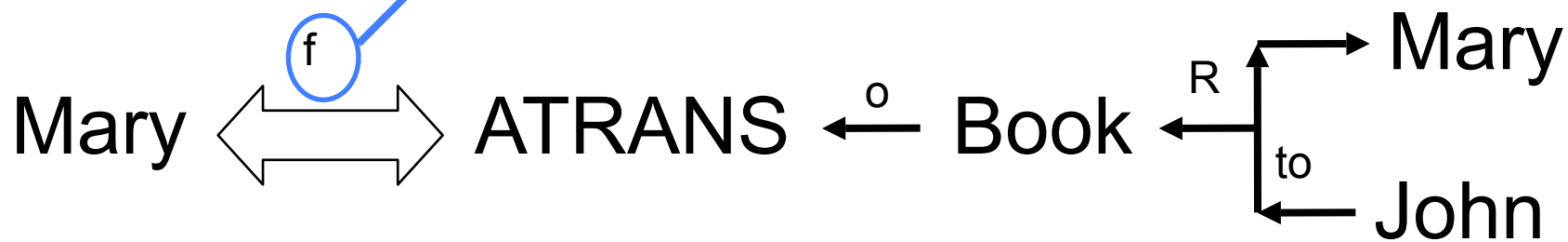



Mary will give John the book  
tomorrow.





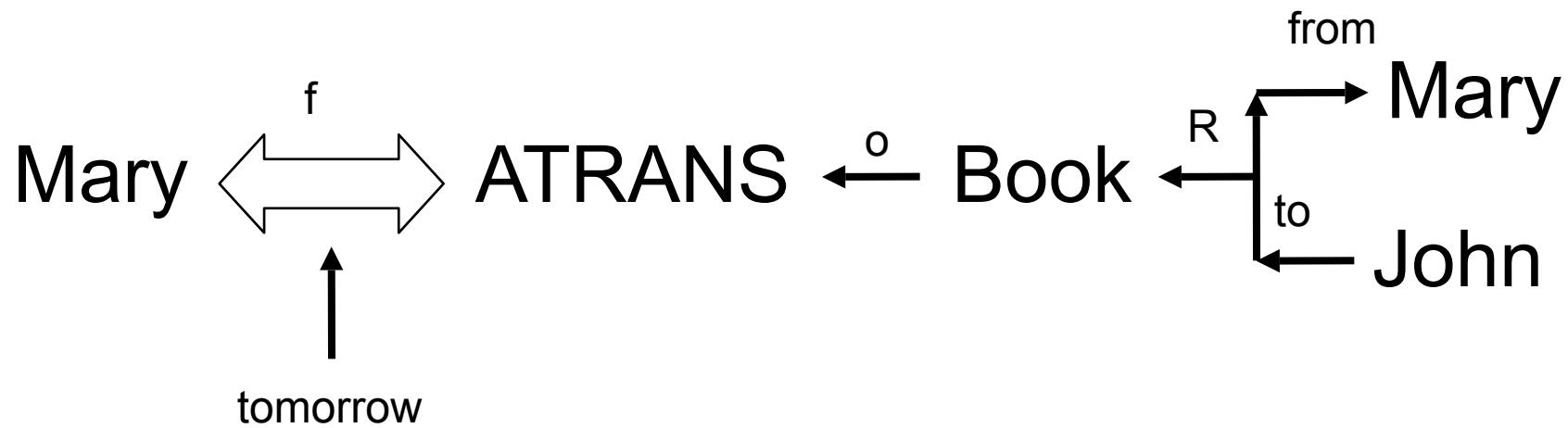

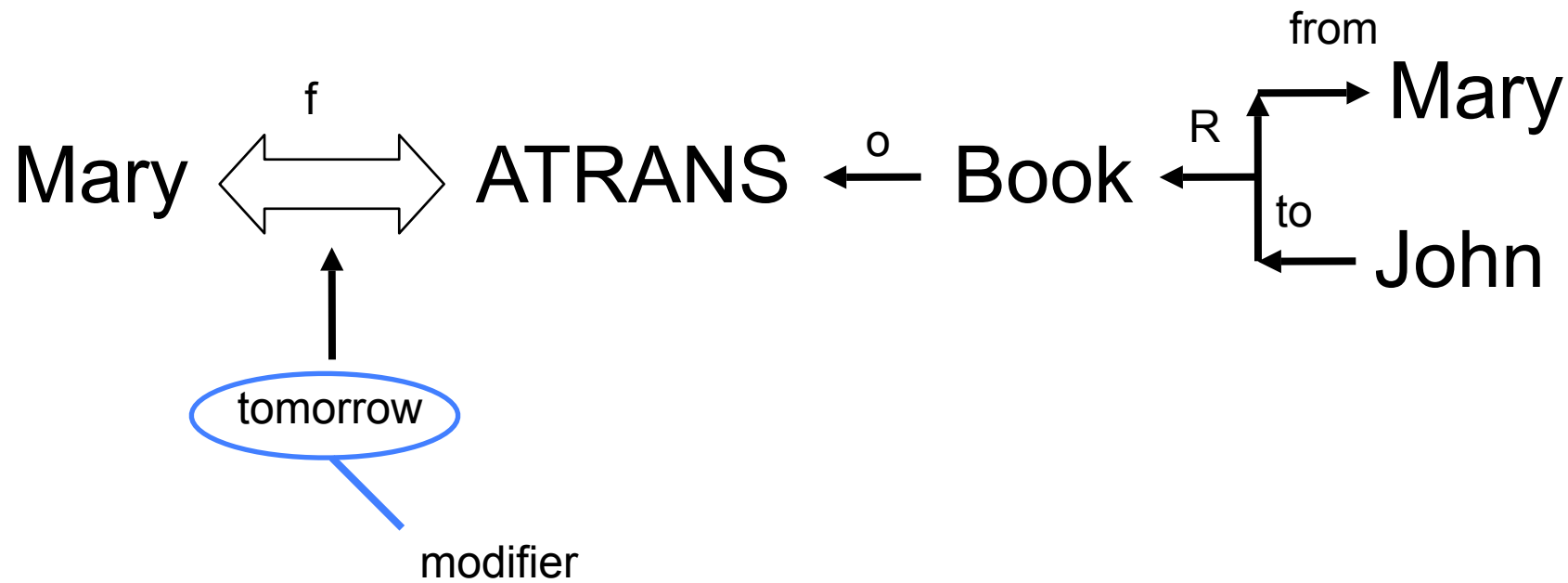



John went to the kitchen.



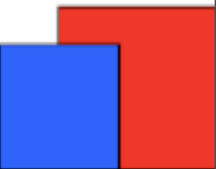
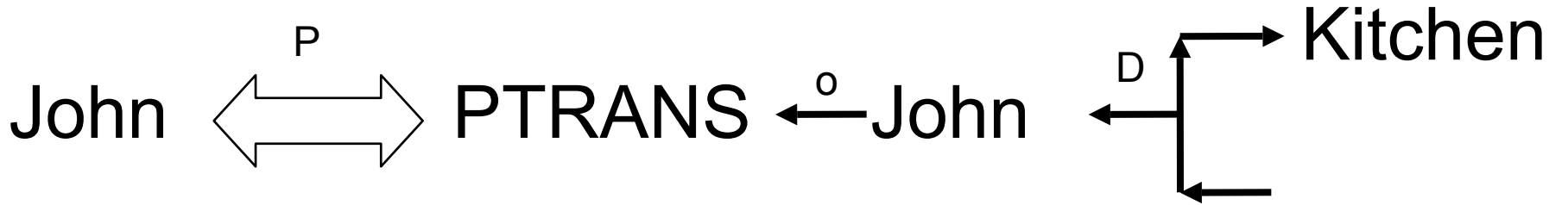



Change in location

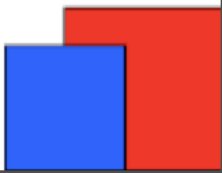
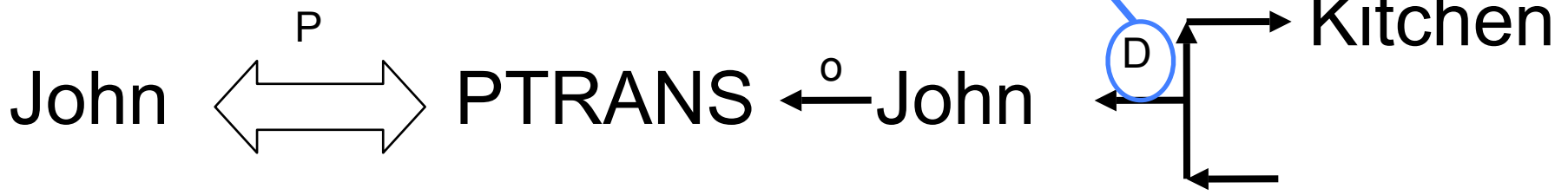



John ate a pizza.





John  $\overset{P}{\longleftrightarrow}$  INGEST  $\overset{o}{\leftarrow}$  pizza

John  $\overset{P}{\longleftrightarrow}$  INGEST  $\overset{o}{\leftarrow}$  pizza  $\overset{R}{\leftarrow}$   $\begin{cases} \text{from} & \text{John} \\ \text{to} & \text{box} \end{cases}$



Smoking can give you cancer.

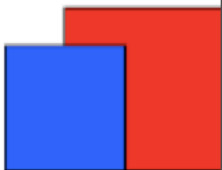



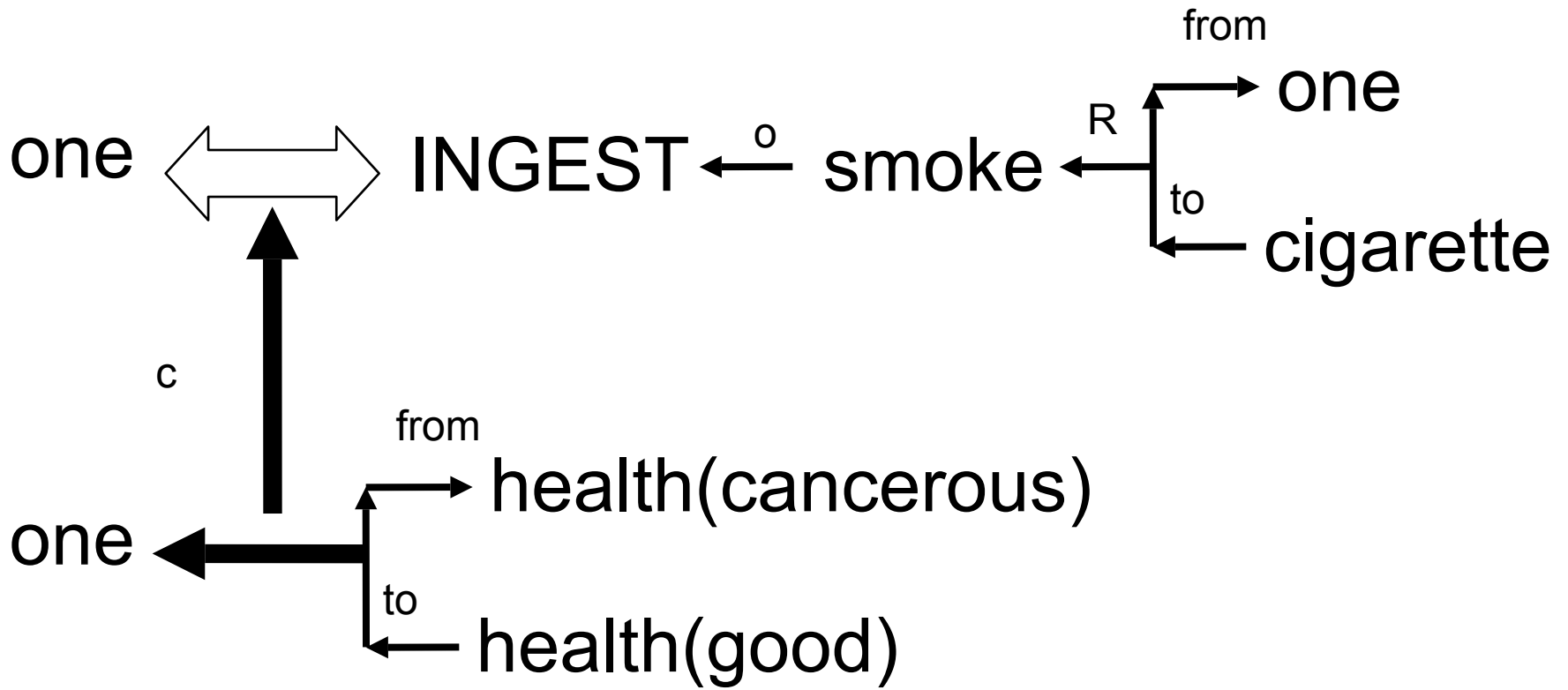

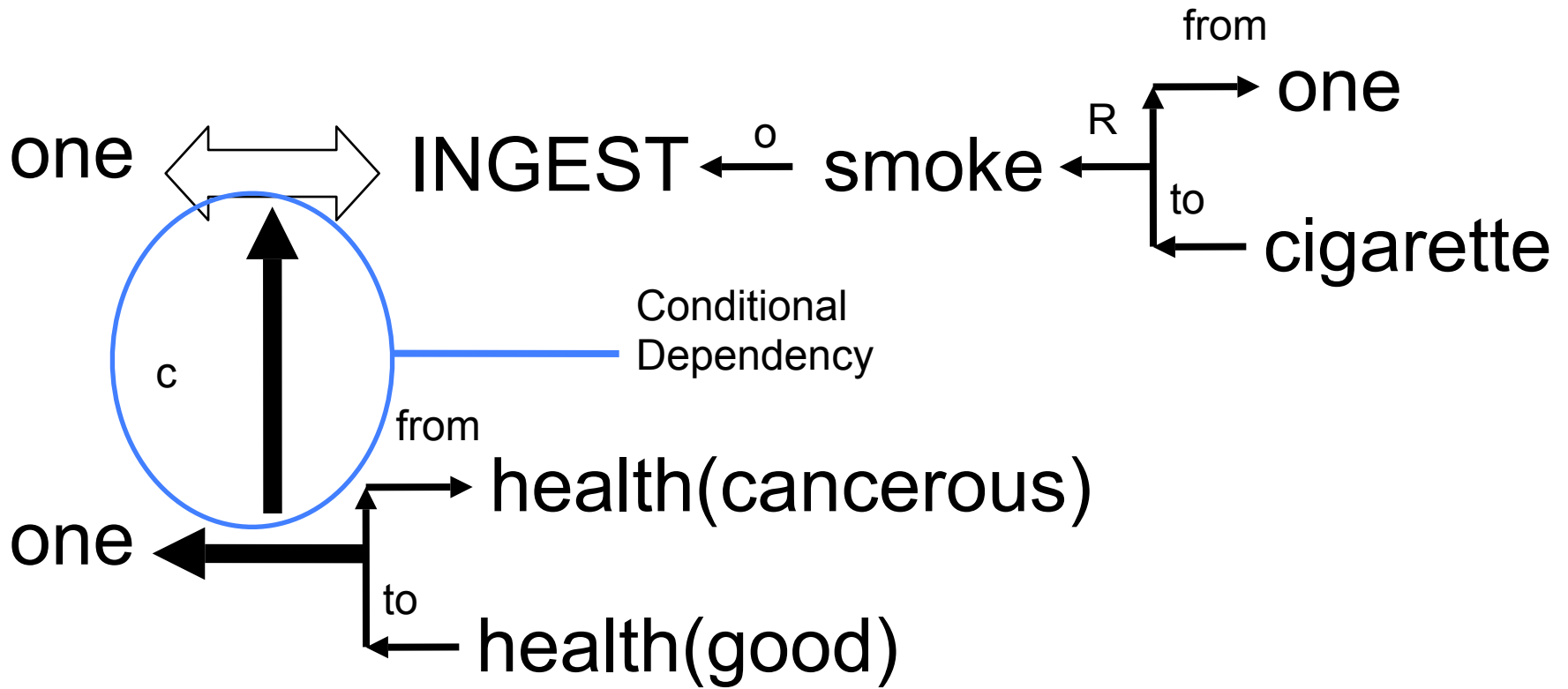



---

John threw the book at Mary.



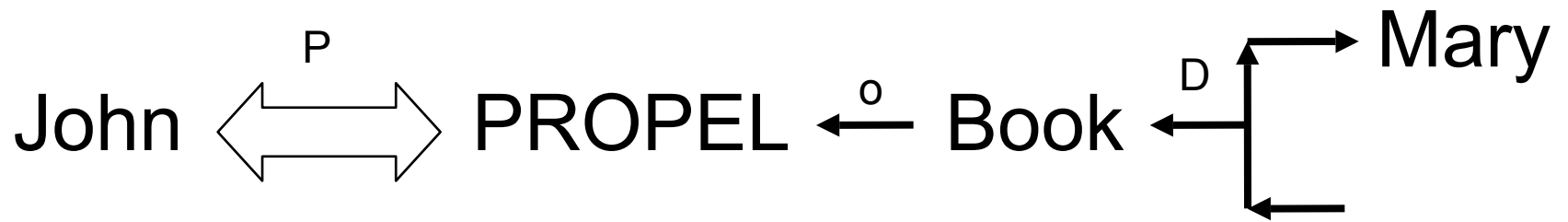

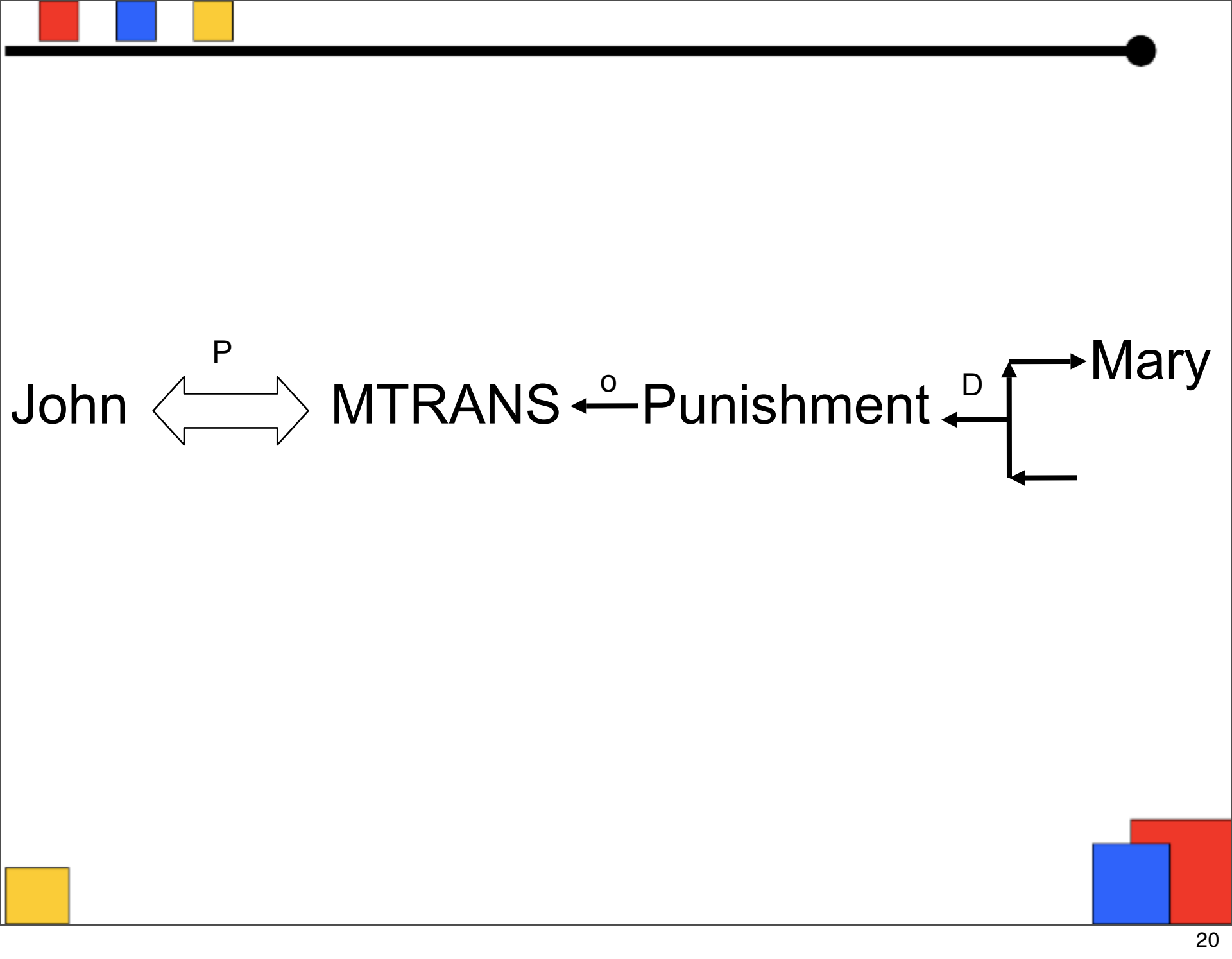



Mary told Jane that she gave  
John the book.

